



BIOJAPAN 2026

PACIFICO, Yokohama (JAPAN)

7-9 October 2026

STORAGE ROOM TOWER

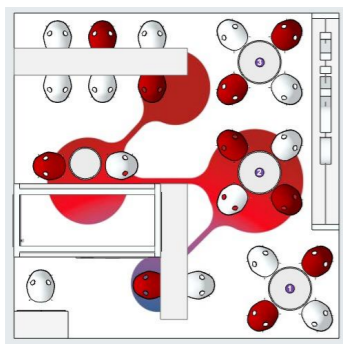
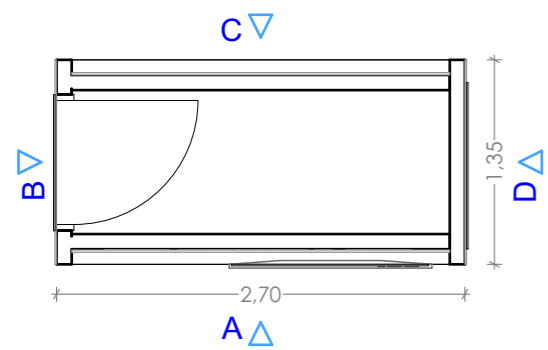
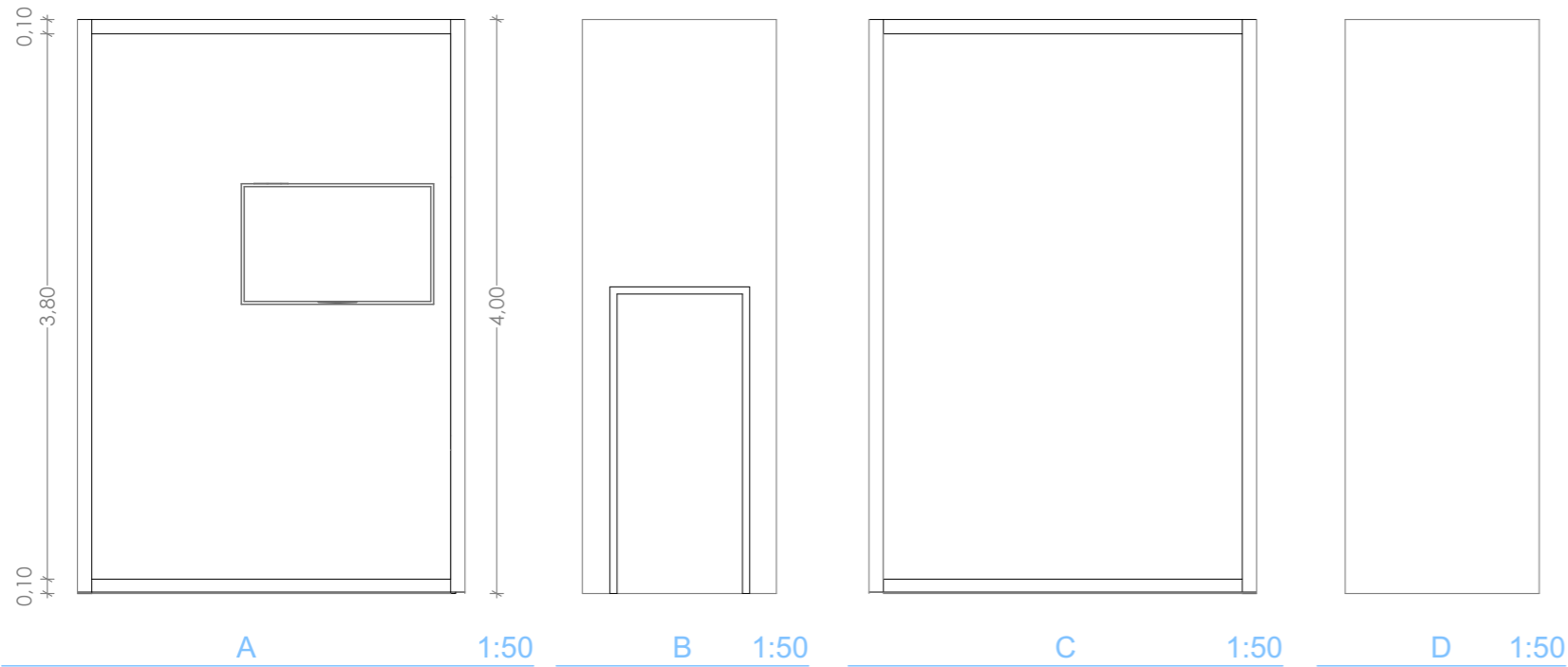

FLOOR

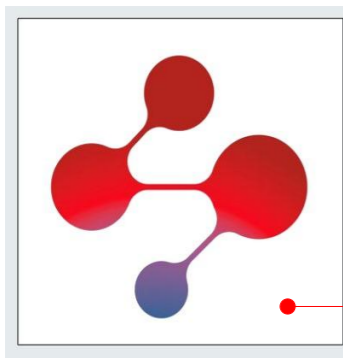

TV 54" OR BIGGER

ALL WALLS COVERED WITH GRAPHICS

FLOOR GRAPHICS

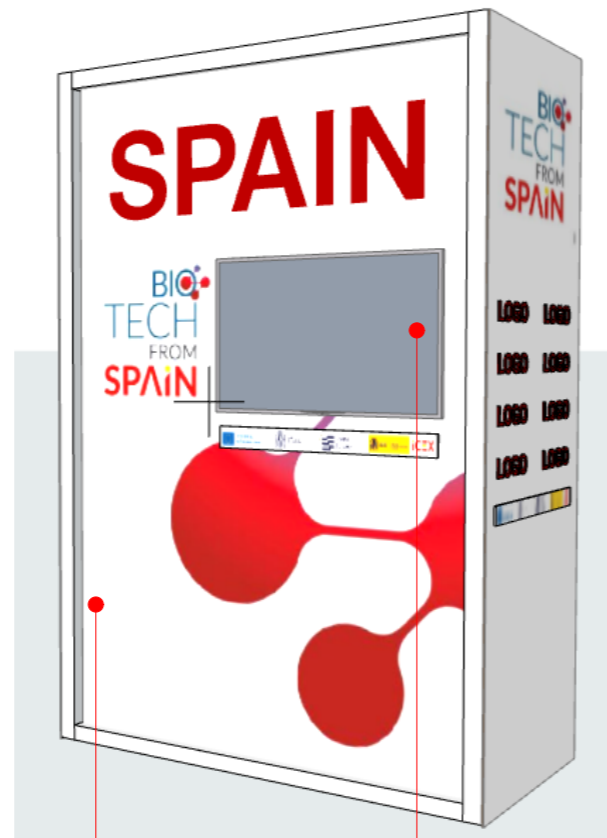

INFORMATION COUNTER

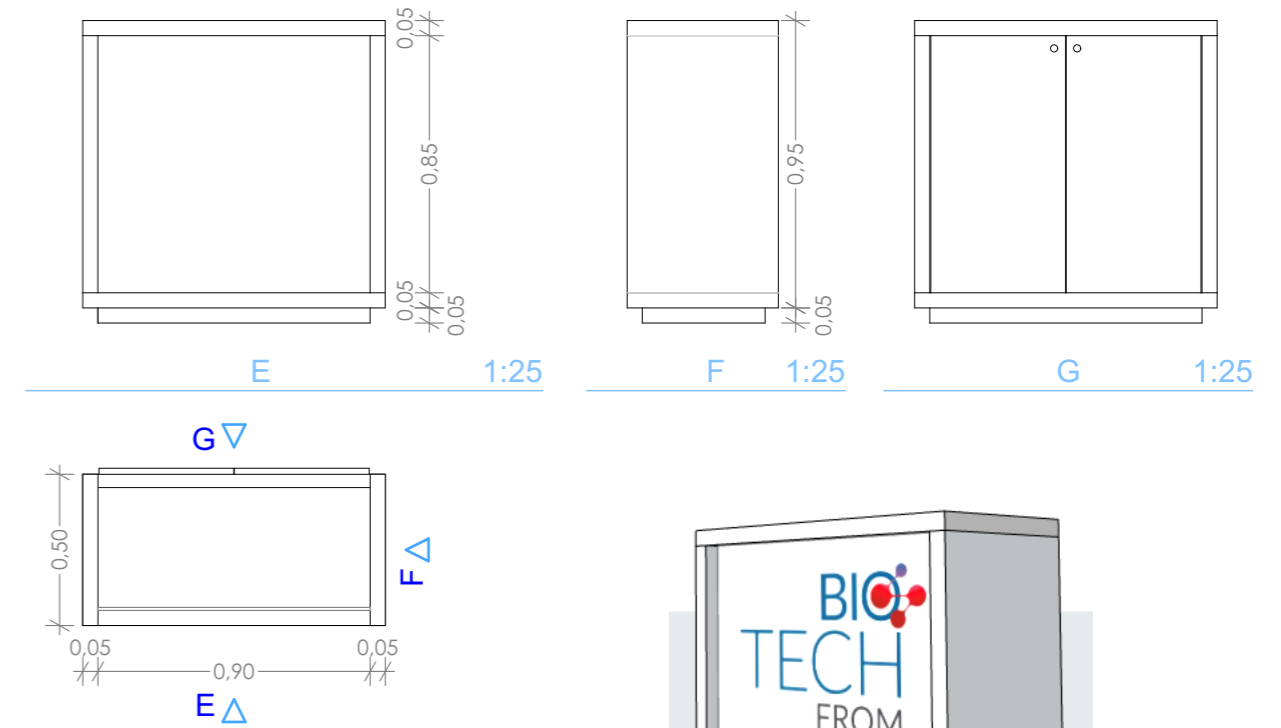

FRONT COVERED WITH GRAPHICS

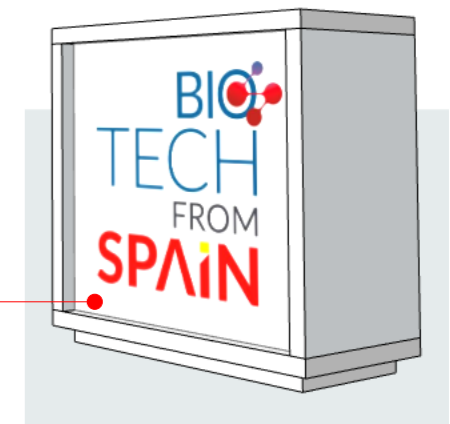

COFFEE CORNER TABLE

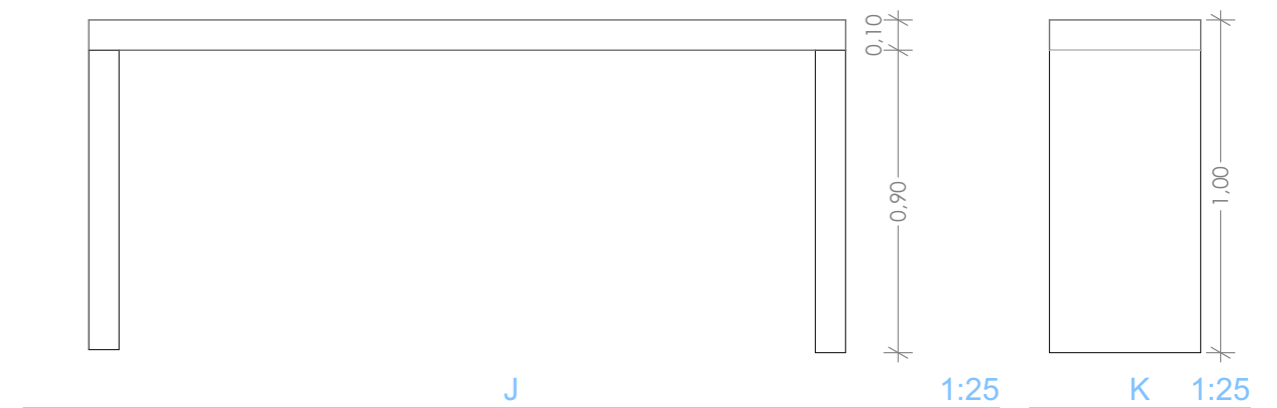

RECESSED DOUBLE SOCKET + USB

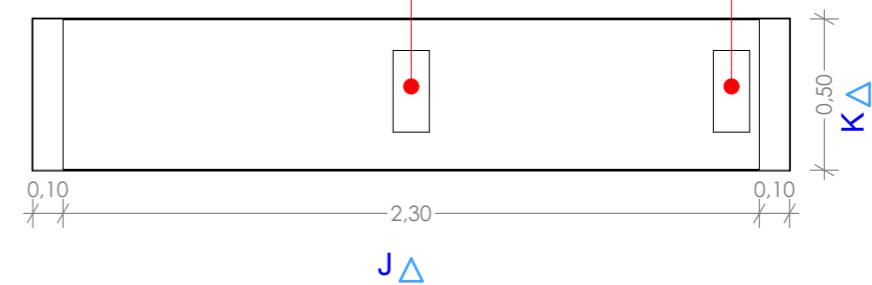

SPAIN SIGN

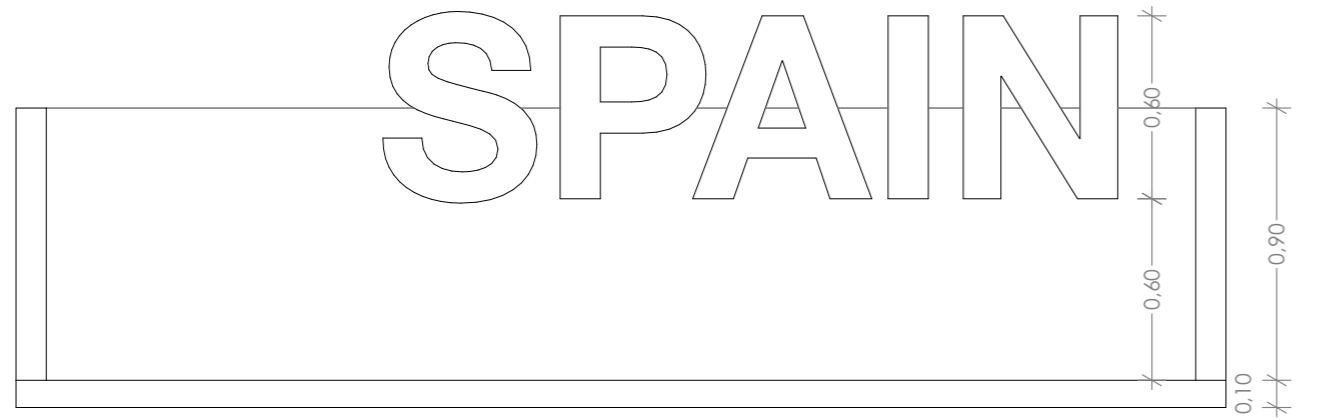

L (1) 1:25 H 1:25

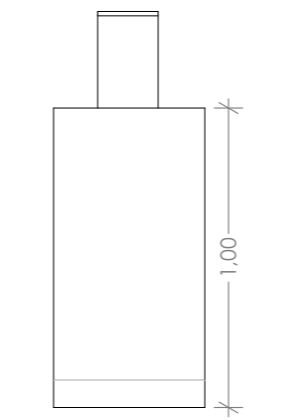
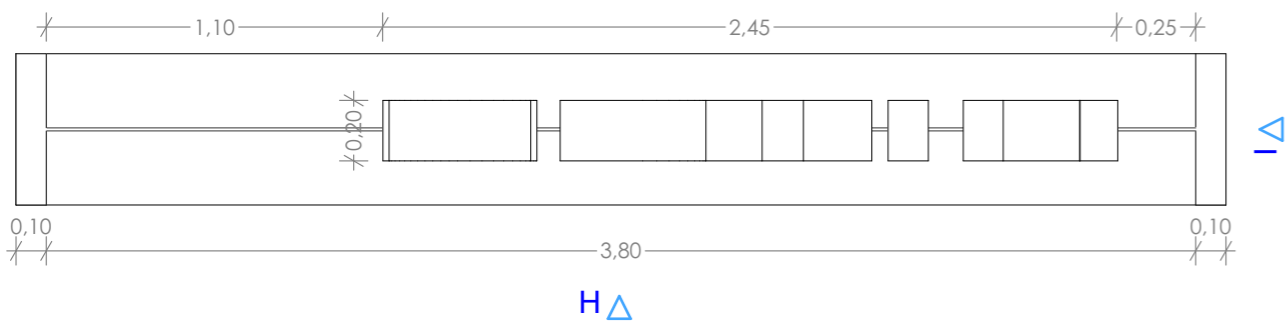

I 1:25

NETWORKING TABLE



M 1:25

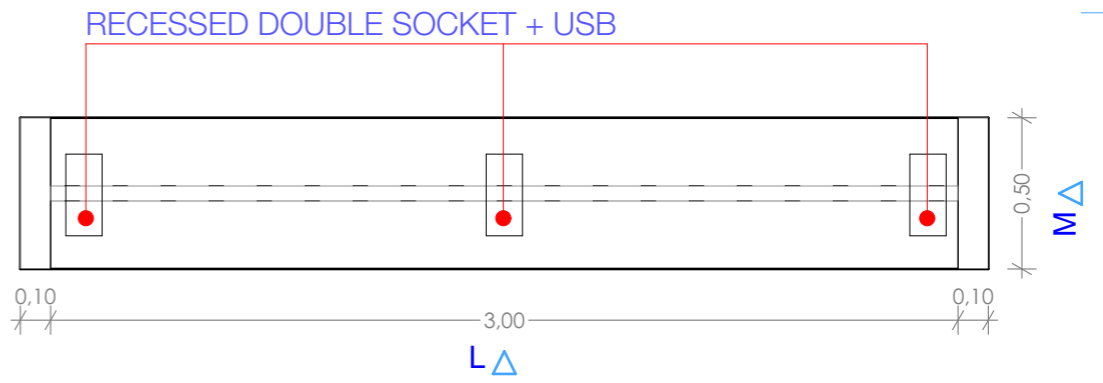

FURNITURE

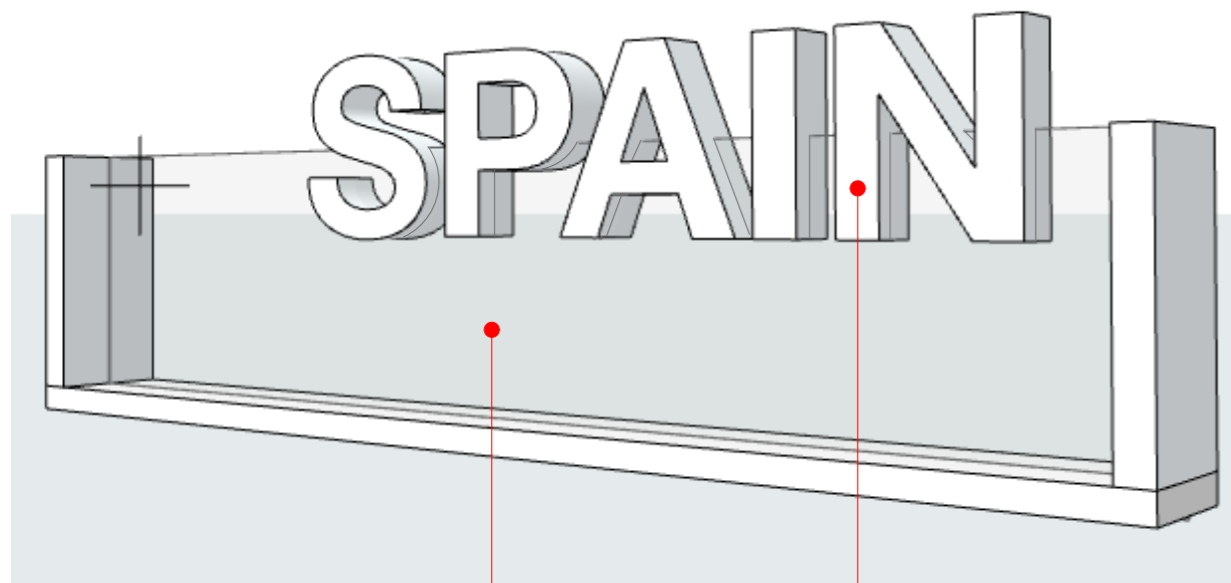

TRANSPARENT PANEL

3D LETTERS
HELVETICA NEUE LT PRO 75 BD OCCIDENTAL



